

HANDLING AND PROCESS SOLUTIONS

FIBER GLASS

DIRECT AND ASSEMBLED ROVING

FULL AUTOMATIC FUNCTIONS

FORMING AREA

DRYING AREA

STRIPPING AREA

REWINDING AREA

PACKAGING AREA



FIBER GLASS DIRECT ROVING

FORMING AREA

- WINDER DOFFING
- EMPTY TUBE INSERTION
- WEIGHTING
- SORTING AND CONTROL
- CONVOYING
- TRACKING

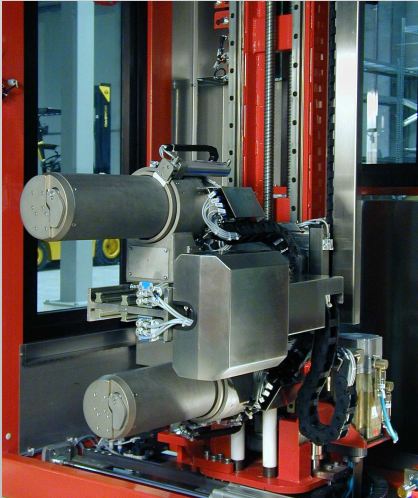
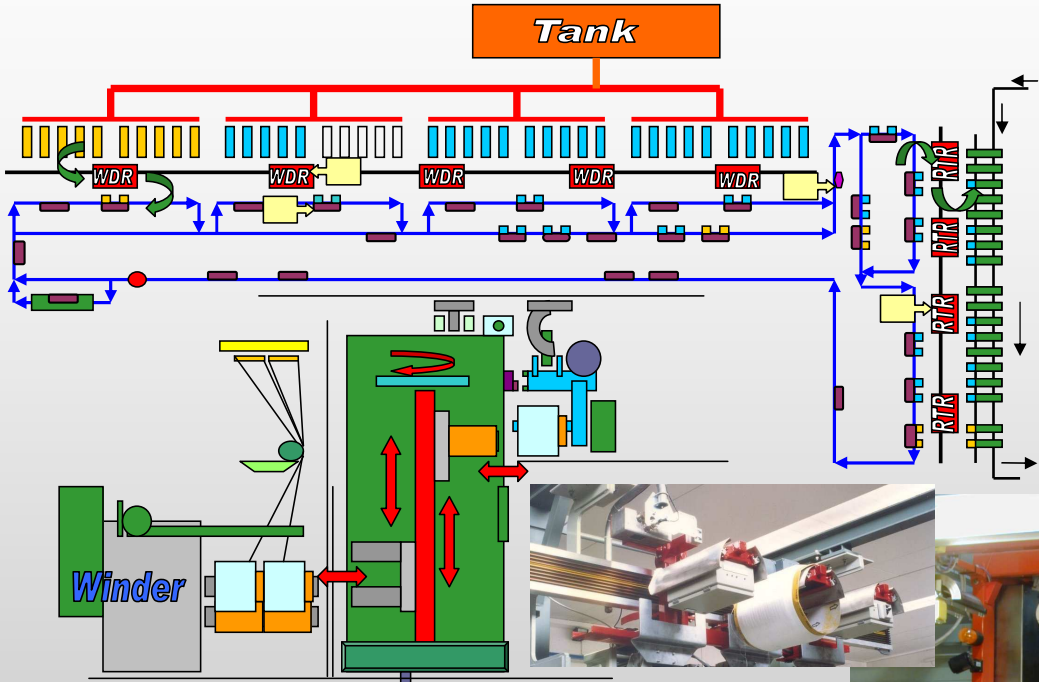



FIBER GLASS ASSEMBLED ROVING

FORMING AREA

- WINDER DOFFING**
- EMPTY TUBE INSERTION**
- WEIGHTING**
- SORTING AND CONTROL**
- CONVOYING**
- TRACKING**

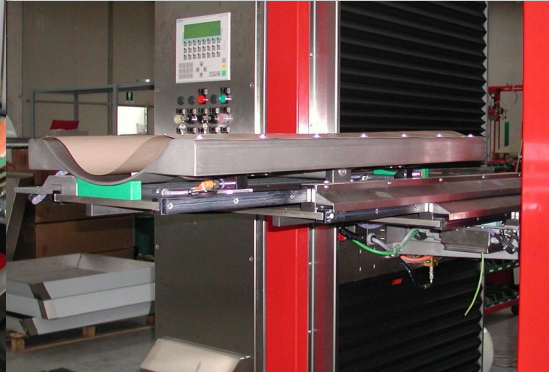
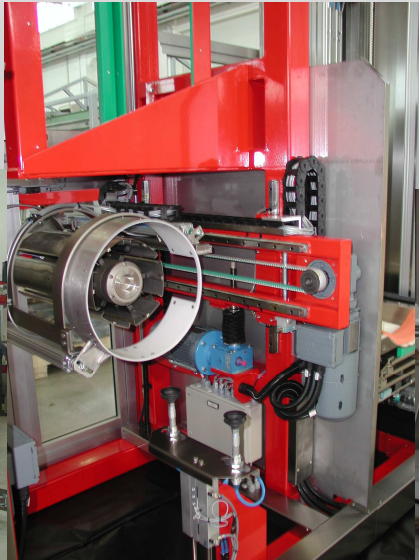
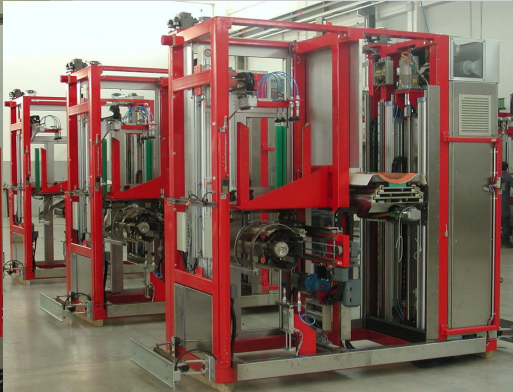
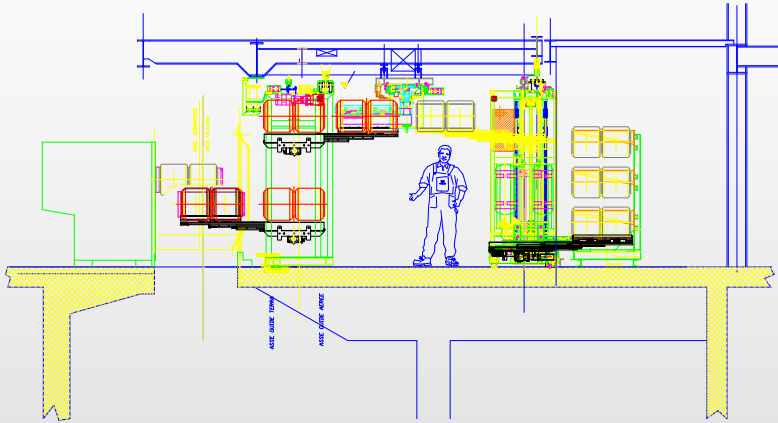

FIBER GLASS

DIRECT AND ASSEMBLED ROVING

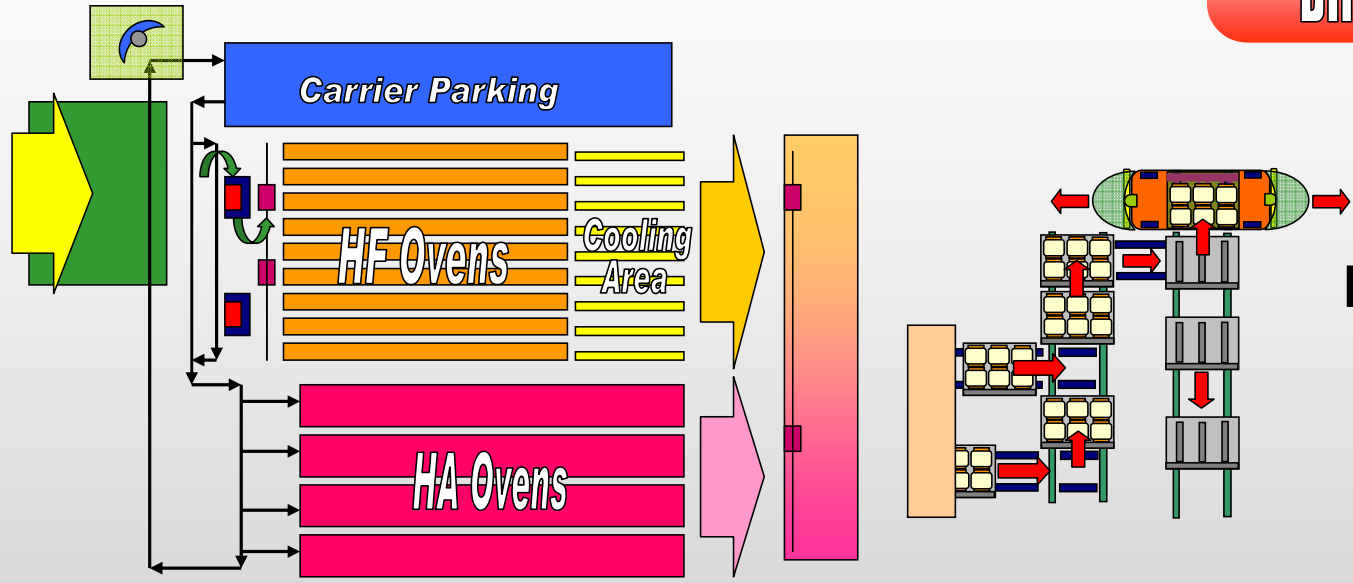

DRYING AREA

HOMOGENIZING AND STOCKING
DRYING
CONVOYING
TRACKING





FIBER GLASS

DIRECT ROVING

STRIPPING AREA

TUBE EXTRACTION

INTERNAL / EXTERNAL STRAND CAPTURE

STRIPPING

STRANDS POSITIONING

CONVOYING TO PACKAGING

TRACKING

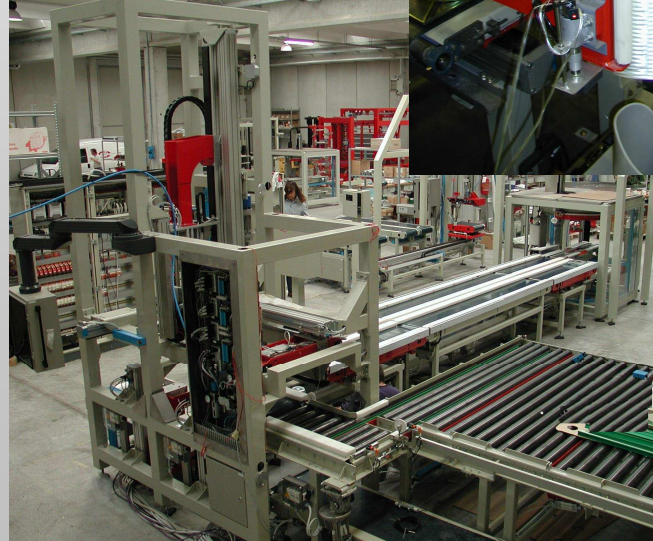
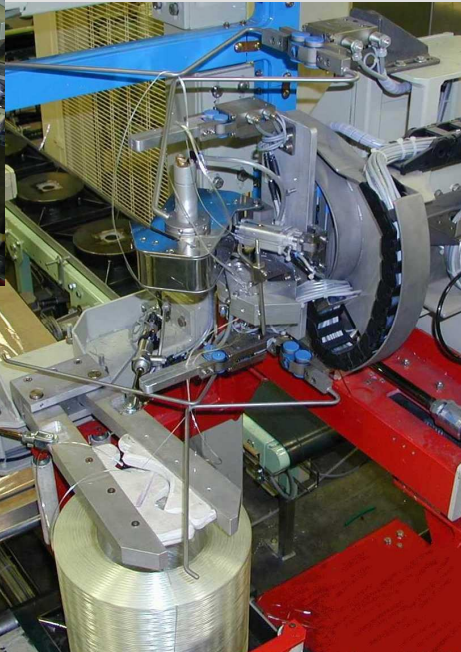
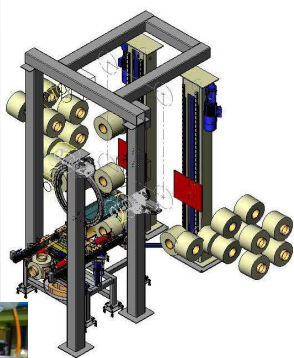
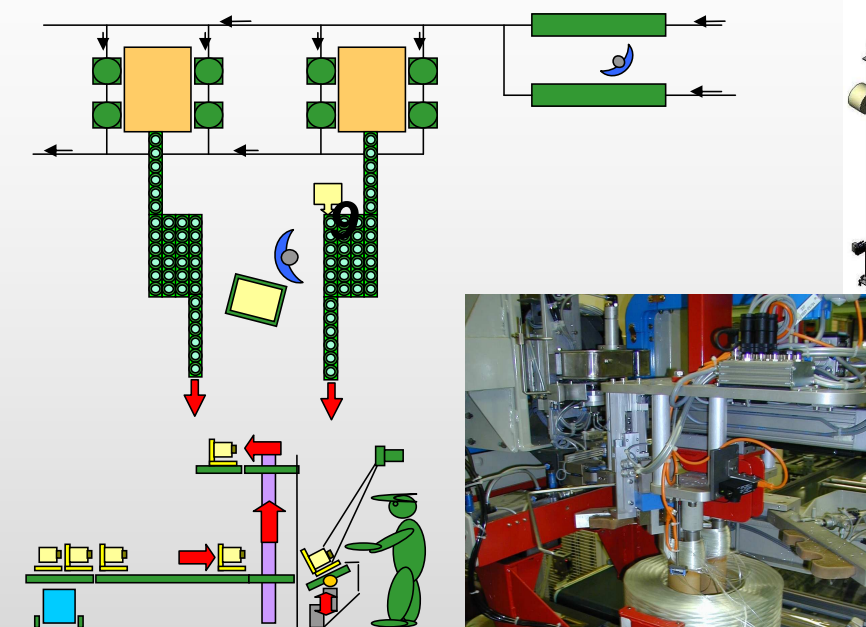

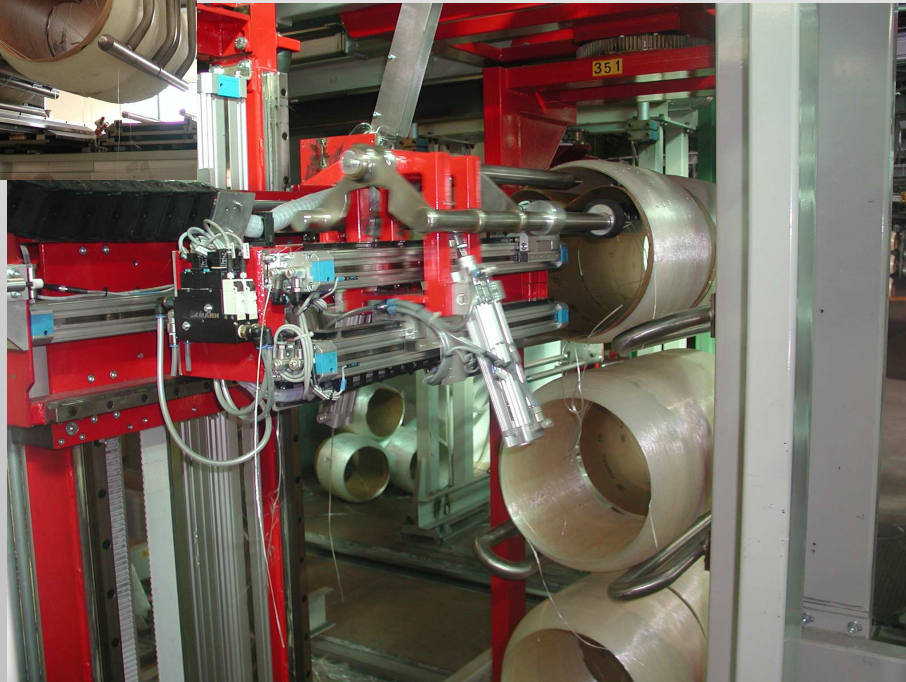
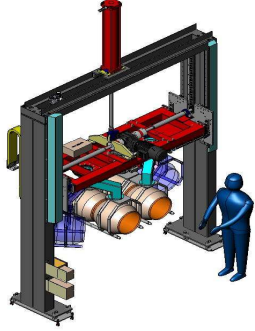

FIBER GLASS ASSEMBLED ROVING

STRIPPING AREA

**TUBE EXTRACTION
INTERNAL STRAND CAPTURE
STRIPPING
STRANDS POSITIONING
CONVOYING TO REWINDING AREA
TRACKING**





FIBER GLASS ASSEMBLED ROVING

REWINDING AREA

- CREEL LOADING FOR SPINNING**
- REWINDING**
- WINDER DOFFING**
- WEIGHTING**
- CONVOYING**
- TRACKING**

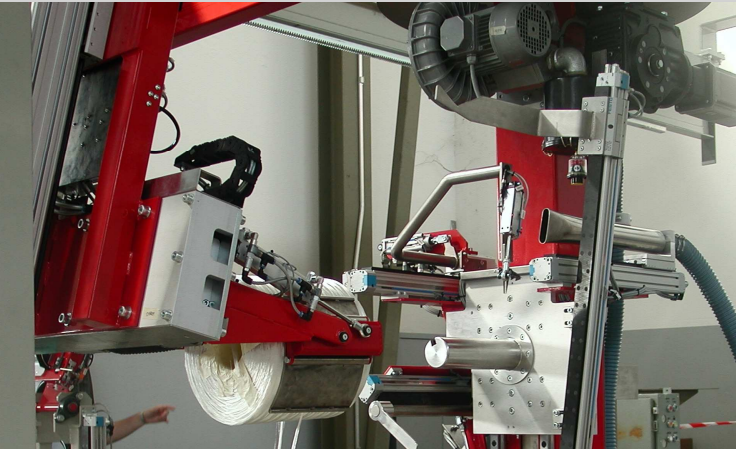
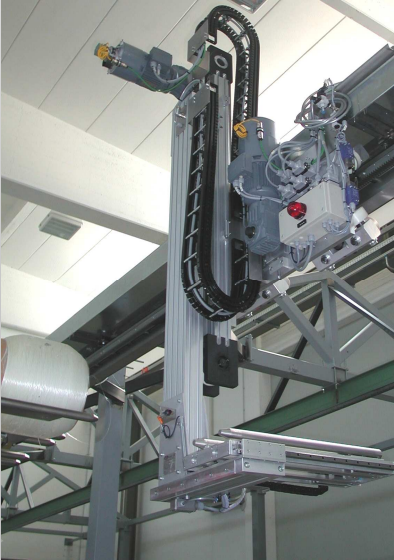
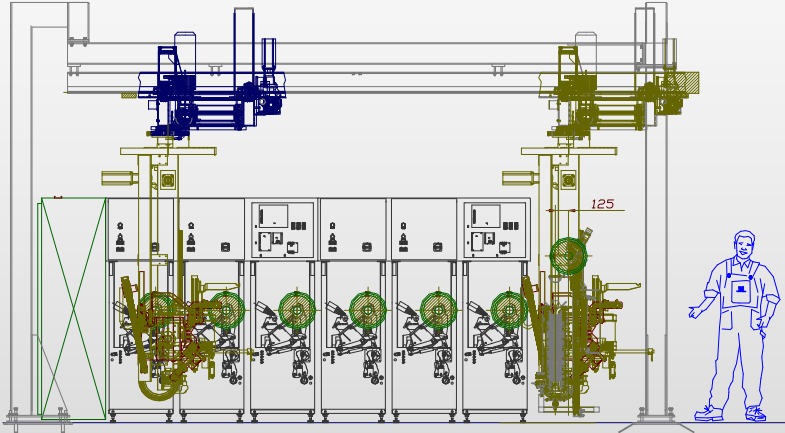
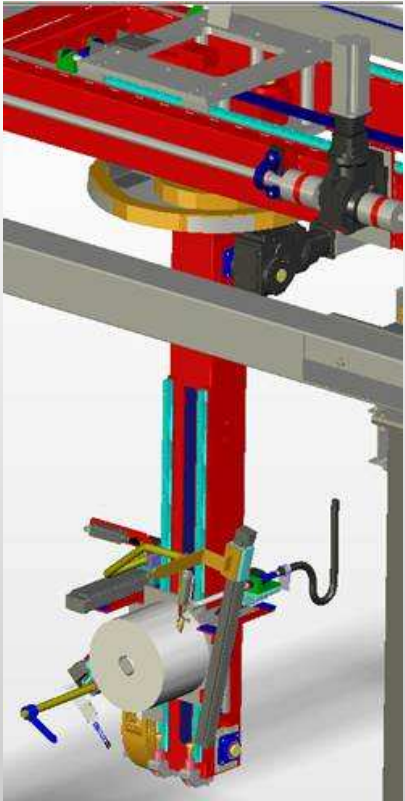



FIBER GLASS

DIRECT AND ASSEMBLED ROVING

PACKAGING AREA

- BOBBIN WRAPPING (NO TENSION)
- BOBBIN WEIGHTING AND LABELLING
- PALLETIZATION
- PALLET PACKAGING, WEIGHTING, LABELLING
- PALLETS STORAGE
- CONVOYING
- TRACKING

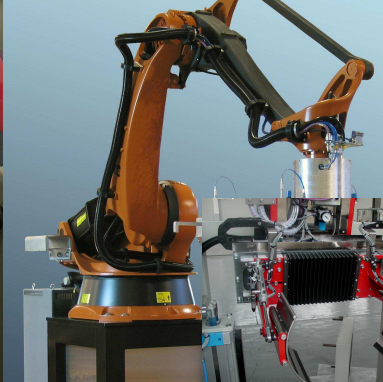
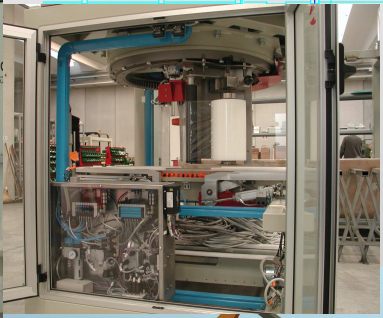
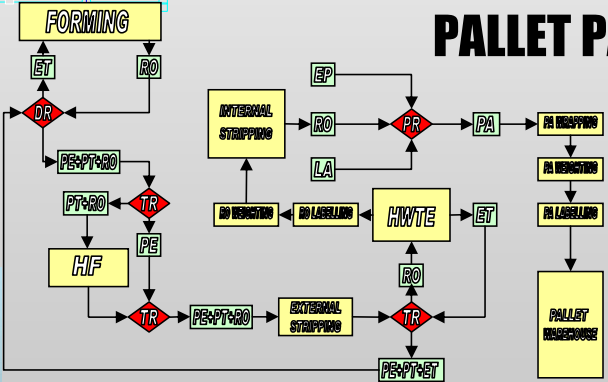
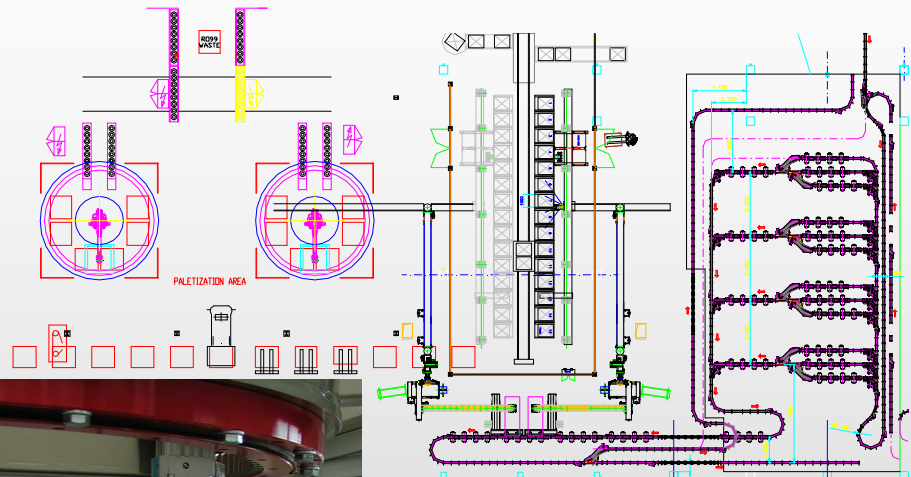



FIBER GLASS

MISCELLANEOUS PROCESSING

WUCS PRODUCT

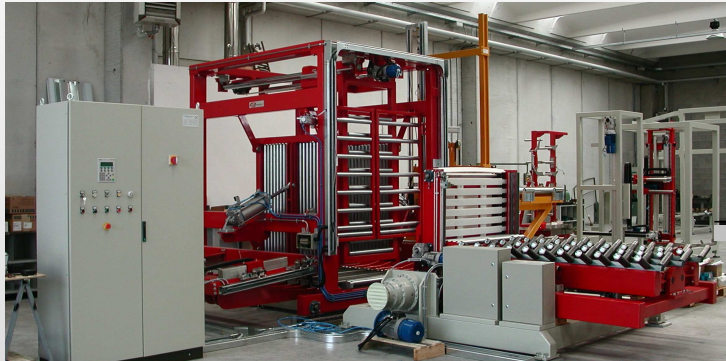
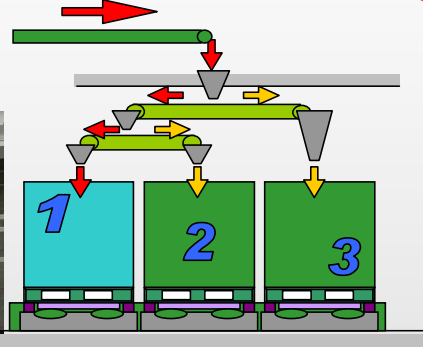

PACKAGING AREA

- ROLLS LABELLING
- PALLETIZATION
- PALLET PACKAGING, WEIGHTING, LABELLING
- PALLETS STORAGE
- CONVOYING
- TRACKING

